

Study on the Properties of Sinusoidal Micro-Textured Ball End Milling Cutter for Milling Titanium Alloy

Qinghua Li – Baizhong Wang – Chunlu Ma – Qingyu Guan – Hu Shi – Kai Xiao – Shihong Zhang*
Changchun University, School of Mechanical and Vehicle Engineering, China

To improve the cutting performance when cutting hard alloys and achieve reasonable optimization of micro-texture parameters, this paper proposes a sinusoidal micro-textured tool, with four parameters set as micro-textured spacing, period, width, and amplitude. Establish three-dimensional models of non-micro-textured and micro-textured milling tools and simulate the milling process using finite element simulation. Study the effects of milling force and milling temperature on tool performance. Prepare micro-textured milling tools for orthogonal experiments, analyse the effects of milling force and the surface roughness of a titanium alloy workpiece, and study the impact of different micro-textured parameters on milling tool performance. Obtain the parameters that have the greatest impact on milling tool performance, and then use genetic algorithm to optimize three sets of parameter combinations. Use the optimized parameters to prepare milling tools for comparative experiments, and then determine the optimal parameter combination. The research results indicate that micro-textured tools can effectively improve the milling performance of the tool, and the spacing between sinusoidal micro-textures has the greatest effect on improving the milling performance of the tool. When the period of sinusoidal micro-texture is 2.87 and the amplitude is 25.13 μm , width is 79.89 μm , and spacing is 134.54 μm , the milling performance of the tool is optimal.

Keywords: Sinusoidal micro-texture, milling performance of milling tools, milling force, milling temperature, surface roughness of the titanium alloy workpiece, parameter optimization, titanium alloy

Highlights

- Calculate the micro-textured placement area on the front face of the milling cutter blade through calculation.
- Propose a sinusoidal micro-texture.
- Verification of milling performance of ball end milling cutters with sinusoidal micro-texture through finite element simulation.
- Obtaining differences in milling performance of cutting tools with different micro-texture factors under different parameters through orthogonal experiments.
- By using algorithms to optimize orthogonal experimental data, the optimal parameters of sinusoidal micro-textured factors were obtained.

0 INTRODUCTION

Titanium alloy, as a new generation of high-temperature structural material, has advantages such as high strength, corrosion resistance, light of weight, and excellent high-temperature resistance. With the rapid development of the automotive manufacturing and aerospace industries, titanium alloys have been promoted towards high temperature resistance, long service life, and high performance [1] and [2]. However, at present, titanium alloy materials still have problems such as poor machinability, high cutting force per unit area, easy wear of tools, and high cutting temperature [3] to [5]. Scholars at home and abroad have found that new tools with micro-textures have better cutting performance than other tools [6]. Ali et al. [7] conducted numerical studies on the cutting process of AISI630 stainless steel using different micro-groove tools, demonstrating that micro-texture can extend the tool's service life. Patel et al. [8] studied the effects of micro-textured parameters on stress and tool wear during titanium alloy cutting. They found that micro-textured width, depth, and edge distance

have a significant impact on cutting force; The depth of micro-texture and the distance from the main cutting edge have a significant impact on the cutting temperature. Pan et al. [9] investigated the effect of cutting speed on the surface quality of micro-textured PCBN tool dry turning hardened bearing steel GCr15. The research results indicated that the effect of cutting speed on surface roughness varies depending on the type of micro-texture, and a microporous texture can minimize the surface roughness of the workpiece. Zhang et al. [10] investigated the influence of cutting edge types and micro-textured parameters on the cutting performance of ball end milling cutters, established a mathematical model, and used a genetic algorithm to optimize the micro-texture and blunt round edge feature parameters of the rear cutting surface. Finally, the blunt round edge radius was 0.04 mm, and the micro texture diameter was 40 μm . Spacing of 175 μm . The distance from the blade is 120 μm . Depth of 80 μm is the most effective positional parameter. Sahu and Jha [11] studied the hybrid manufacturing of AISI316L. The research results indicate that different structural characteristics lead

to differences in the machinability of materials. Yang, et al. [12] studied the effect of micro-texture on the milling performance of ball end milling cutters and the anti-wear and friction reduction performance of surface micro-texture. The research results found that under dry cutting conditions, micro-texture can reduce milling force, lower milling temperature, reduce tool front face wear, and extend tool life during the milling process of ball end milling cutters.

Sinusoidal micro-textures can optimize the mechanical properties of materials by adjusting their shape, size, and distribution parameters. At the same time, they can increase the interface area and stress distribution of the material, thereby improving its strength and toughness, making the material more durable and reliable.

Therefore, in order to solve the problems of large milling force, high milling temperature and low surface quality of a titanium alloy workpiece when milling titanium alloy with a ball end milling cutter and improve the milling performance of milling tools, this article is based on sinusoidal micro-texture. Orthogonal experiments are used to simulate the milling process using finite element simulation. The influence of micro-texture on the milling performance of the tool is studied through changes in force and temperature. Then the sinusoidal micro-texture was prepared on the rank tool surface by laser processing technology, and the micro-textured parameters that have the greatest impact on the milling performance of the tool are determined through experiments. Finally, a mathematical model is established, optimizing the parameter size based on genetic algorithm to obtain the optimal parameter combination.

1 FINITE ELEMENT SIMULATION

Ti6Al4V titanium alloy is widely used in the manufacturing industry due to its excellent processing performance, but its processing efficiency is low and it wears easily, making it a difficult material [13] to machine. This article uses finite element simulation software (Abaqus2021) to simulate the milling of Ti6Al4V titanium alloy with a hard alloy ball end milling cutter. The milling performance of the tool is comprehensively evaluated using milling force and milling temperature as evaluation criteria, and the influence of micro-texture on the milling performance of the tool is explored.

1.1 Distribution of Micro-Textured Positions

The position of micro-texture plays a crucial role in the entire cutting process, and the reasonable distribution of micro-texture can effectively improve cutting performance. In order to fully participate in milling, the micro-texture is set within the milling area of the tool. The milling area of the tool is related to the angle between the workpiece and the plane, the milling depth, and the size of the tool radius. The distribution area of micro-texture is shown in Fig. 1.

Where a_p is the milling depth, θ is the inclination angle, R_1 is the maximum milling radius, R_2 is the minimum milling radius, points A and B are the contact points between the tool and the workpiece, and V_0 is the tool speed. Determine the milling area by calculating the maximum and minimum milling radii, expressed as:

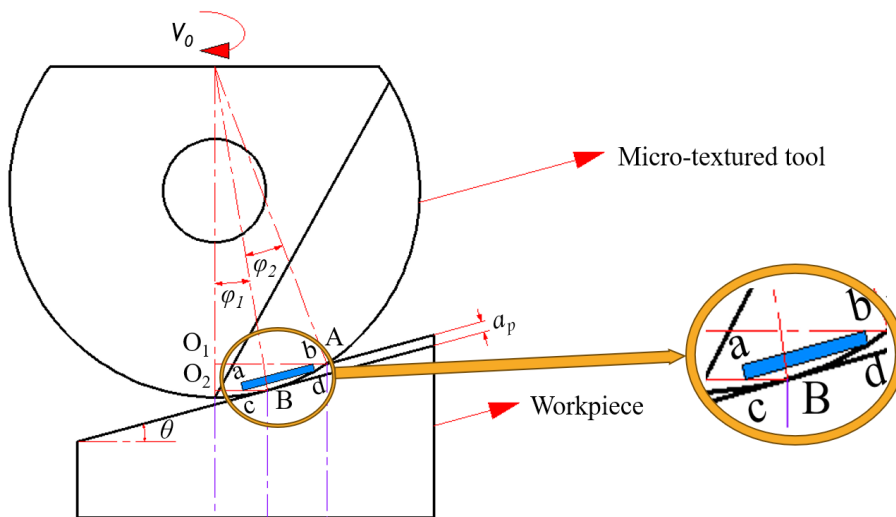

Fig. 1. Distribution map of micro-textured areas on the front face of ball end milling cutter blades

$$\varphi_1 = \theta = 15^\circ, \tag{1}$$

$$\varphi_2 = \arccos\left(\frac{R - a_p}{R}\right), \tag{2}$$

$$R_1 = R \sin\left(\varphi_1 + \arccos\frac{R - a_p}{R}\right), \tag{3}$$

$$R_2 = R \sin \varphi_1. \tag{4}$$

Given the tool radius and workpiece inclination angle, calculate the sizes of R_1 and R_2 , and construct a rectangular micro-textured region abcd in the O_1O_2BA region.

1.2 Simulation Model Establishment

During the cutting process, micro-texture can reduce the contact area between the tool and chip, as well as reduce frictional stress and cutting temperature, and its effect often changes with the change of micro-textured parameters [14] and [15]. Therefore, in order to explore the influence of different parameters of sinusoidal micro-texture on the milling performance of milling tools, this paper sets four parameters: period, width, amplitude, and micro-textured spacing as variables for research. The established ball end milling cutter model and sinusoidal micro-textured ball end milling cutter model are shown in Fig. 2, and the sinusoidal micro-textured model is shown in Fig. 3.

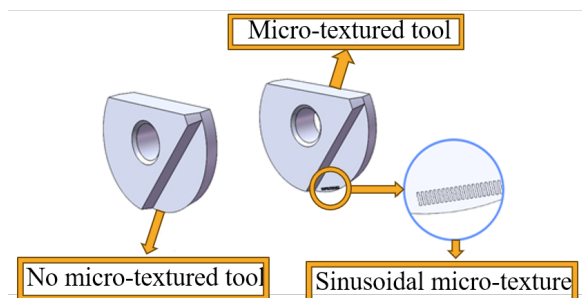

Fig. 2. Three dimensional simulation models of non-micro-textured ball end milling cutters and sinusoidal micro-textured ball end milling cutters

The three-dimensional model of the ball end milling cutter is divided into tetrahedral grids. The minimum grid size of the tool is 0.01 mm, the maximum grid size is 0.05 mm, the minimum grid size of the workpiece is 0.025 mm, and the maximum grid size is 0.05 mm. The finite element simulation model of the interaction between the tool and the workpiece

is shown in Fig. 4. The design milling amount scheme is: $v_c = 120$ m/min, $f_z = 0.08$ mm/z, $a_p = 0.5$ mm.

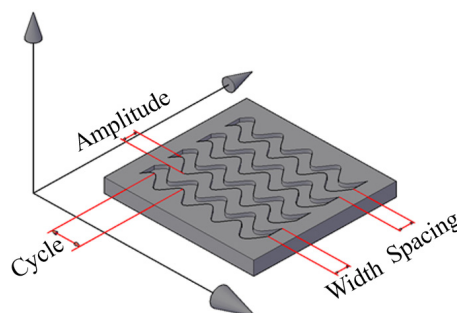

Fig. 3. A three-dimensional model of sinusoidal micro-texture

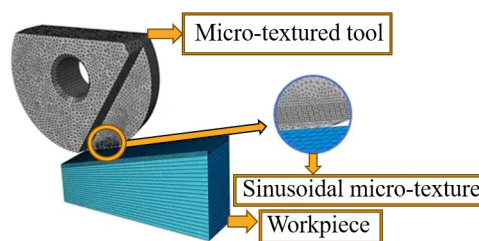

Fig. 4. Assembly model of tool-workpiece in finite element simulation

The finite element simulation analysis adopts the Johnson Cook constitutive model, which can meet the simulation material requirements under various conditions. It can accurately reflect the large strain and thermal softening effects of materials during the milling process [16] to [18]. The workpiece material is Ti6Al4V titanium alloy, and its constitutive model parameters are shown in Table 1. The empirical formula of the Johnson Cook constitutive model is:

$$\sigma = \left[A + B(\varepsilon)^n \right] \cdot \left[1 + C \ln\left(\frac{\dot{\varepsilon}_p}{\dot{\varepsilon}_0}\right) \right] \cdot \left\{ 1 - \left(\frac{t - t_0}{t_m - t_0} \right)^m \right\}, \tag{5}$$

among them σ is material flow stress, A material yield limit, B strain change coefficient, C strain rate reinforcement factor, m thermal softening parameters, n strain hardening parameters, ε equivalent plastic strain, p equivalent plastic strain rate, $\dot{\varepsilon}_0$ reference value of strain rate, t deformation temperature, t_0 room temperature, and t_m material melting point temperature.

Table 1. Johnson Cook constitutive model parameters of Ti6Al4V [19]

A [MPa]	B [MPa]	C	n	m	t_0 [°C]	t_m [°C]
860	683.1	0.035	0.47	1	25	1650

Using the orthogonal experimental method for milling simulation, a four factor, three level orthogonal experiment is designed. The period of the sinusoidal micro-texture is 2 to 4, the width of the micro texture is 0.02 mm to 0.08 mm, the amplitude of the micro texture is 0.1 mm to 0.2 mm, and the spacing between the micro-textures is 0.1 mm to 0.2 mm. The factor and level table are shown in Table 2, and the orthogonal experimental table is shown in Table 3.

Table 2. Factors and levels table

Level	Factors			
	Cycle [s]	Width [mm]	Amplitude [mm]	Spacing [mm]
1	2	0.02	0.01	0.1
2	3	0.05	0.03	0.15
3	4	0.08	0.05	0.2

Table 3. Orthogonal experimental table for finite element simulation test and milling test

Experiment number	Cycle [s]	Amplitude [mm]	Width [mm]	Spacing [mm]
1	2	0.01	0.02	0.1
2	2	0.03	0.05	0.15
3	2	0.05	0.08	0.2
4	3	0.01	0.05	0.2
5	3	0.03	0.08	0.1
6	3	0.05	0.02	0.15
7	4	0.01	0.08	0.15
8	4	0.03	0.02	0.2
9	4	0.05	0.05	0.1

1.3 Simulation Results and Analysis

Finite element analysis was conducted on the non-micro-textured ball end milling cutter and 9 groups of micro-textured ball end milling cutters. The feed and rotational motion of the ball end milling cutter during the milling process will generate milling forces, including tangential force, radial force and vertical force. At the same time, the high-speed rotation of the tool generates a large amount of heat concentrated on the milling cutter edge. Therefore, three types of milling force data for each group of ball end milling cutters are obtained through finite element analysis. The combined force is calculated according to Eq. (6). The same node is taken at each group of milling cutter edges, and the milling temperature changes of the nodes are analyzed to obtain simulation data, as shown in Fig. 5. From Fig. 5 it can be seen that the simulation results of milling force and milling

temperature are constantly changing due to the different sizes of micro-textured parameters in each group of experiments.

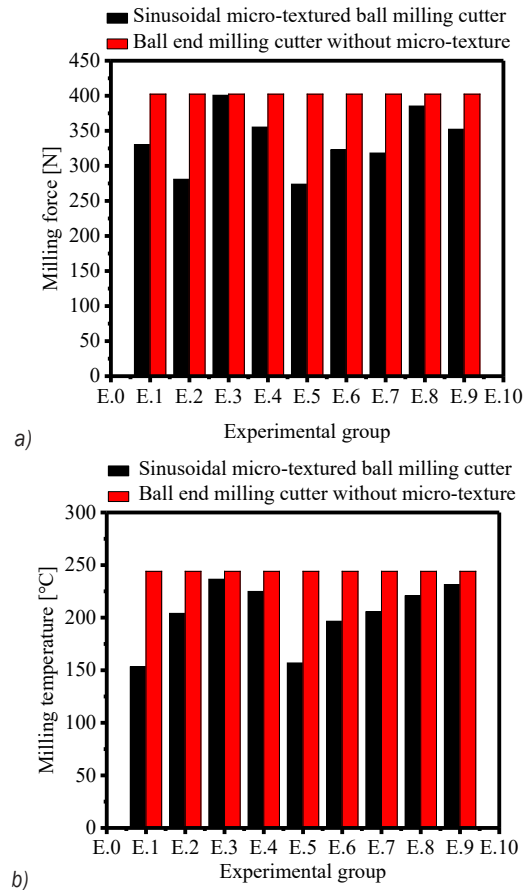

Fig. 5. Finite element simulation data image with parameter combinations obtained from nine sets of finite element simulation experiments; a) milling force variation, and b) variation of milling temperature

The simulation results of micro-textured ball end milling cutters with different parameter sizes are better than those of non-micro-textured ball end milling cutters. Analyzing the reasons, on the one hand, the microgroove-texture can store the chips generated during the milling process, effectively reducing the contact between the chips and the tool tip, reducing tool wear and thus reducing milling force. On the other hand, the existence of the microgroove-texture increases the heat dissipation space during the milling process, which is conducive to the release of heat generated during milling, thereby reducing the milling temperature. Combining simulation test data, it was found that the fifth group had the best results.

$$F = \sqrt{F_x^2 + F_y^2 + F_z^2}, \quad (6)$$

among them F is milling force combined force; F_x tangential force; F_y radial force; and F_z vertical force.

Through the finite element simulation results, it can be concluded that micro-texture can improve the milling performance of milling tools to a certain extent. Preparing micro-texture on the surface of milling cutters can effectively reduce milling force and lower milling temperature.

2 MILLING EXPERIMENT

Prepare sinusoidal micro-textured ball end milling cutters with different parameters based on the established three-dimensional model for orthogonal experiments.

2.1 Experimental Materials and Equipment

The cutting tool required for this milling test is a hard alloy ball-end milling cutter, whose model is BNM-200-S, and the cutting tool style is shown in Fig. 6. The two-dimensional plan is shown in Fig. 7. The cutter is suitable for processing titanium alloy, stainless steel, cast iron and other materials, and its main dimensions are shown in Table 3. Milling parameters used in the test are shown in Table 4. In the experiment, the semiconductor single-mode laser marking machine zt-y-50w was used to prepare micro-texture. Leica ultra-depth of field microscope model DVM2500 was used to observe the micro-texture morphologies of nine groups with different parameter sizes. Each micro-texture was observed three times to obtain the best results. The image displayed by micro-texture parameters is shown in Fig. 8. The tool used in the experiment is cemented carbide ball end milling cutter, and Ti6Al4V titanium alloy is used as the processing workpiece. The numerical control milling machine model is CMV-850A. The milling experimental platform is shown in Fig. 9.



Fig. 6. The carbide ball end milling cutter blade

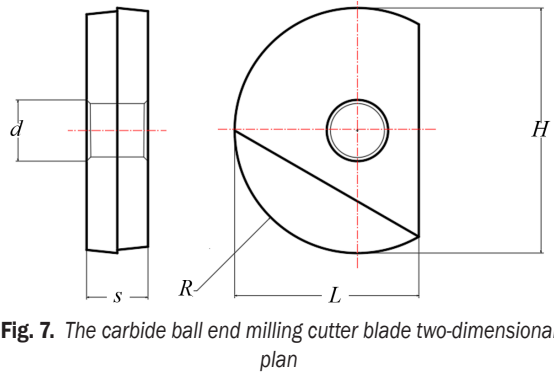

Fig. 7. The carbide ball end milling cutter blade two-dimensional plan

Table 3. Main dimensions of ball end milling cutter blade

Dimension [mm]	Name				
	d	s	R	L	H
	5	5	10	15	20

Table 4. Main dimensions of ball end milling cutter blade

v_c [mm/s]	f_z [mm/z]	a_p [mm]
120	0.08	0.5

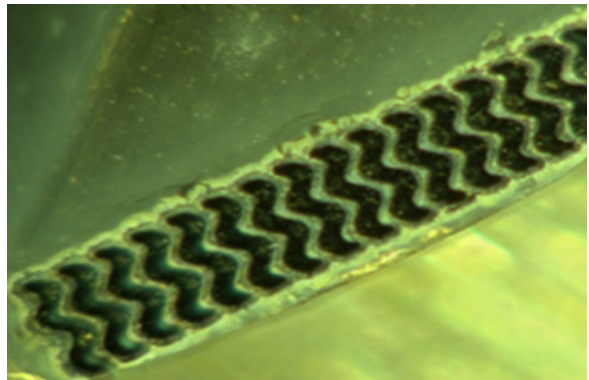

Fig. 8. Sinusoidal micro-textured images under a microscope

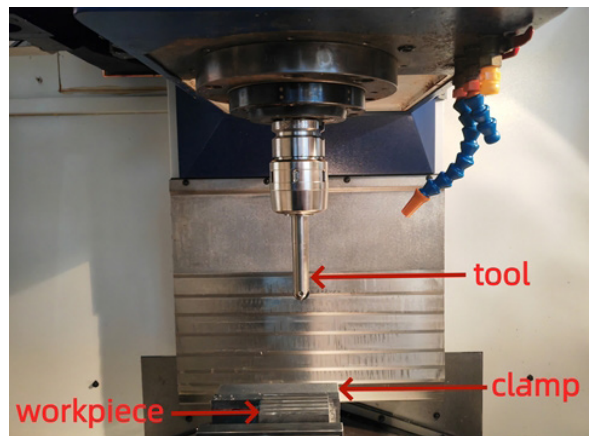

Fig. 9. Milling experiment platform

2.2 Analysis of the Milling Force

Measure the radial force, axial force, and tangential force using a force measuring instrument, and combine the forces in the three directions to obtain the cutting force. The measured milling force of the non-micro-textured tool and the milling force of each group of micro-textured tools are shown in Fig. 10. From Fig. 10 it can be seen that the milling force generated by the micro-textured tool during the milling process is reduced at a certain rate compared to the non-micro-textured tool. After calculation, the highest reduction rate of milling force generated by the sine type micro-textured ball end milling cutter compared to the non-micro-textured ball end milling cutter in the nine groups of experiments can be close to 30%. Furthermore, it has been verified that micro-textured structures can improve the cutting performance of cutting tools, and it was found in the experiment that the fifth group of tests generated the smallest milling force, which was 318.58 N.

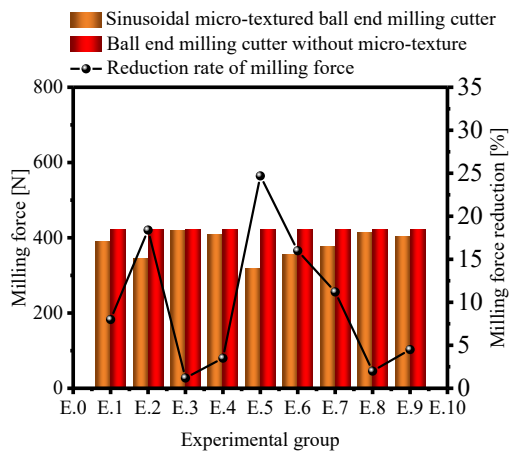

Fig. 10. Comparison of milling force data between nine different parameter combinations of sinusoidal micro-textured ball end milling cutter milling experiments and non-micro-textured tool milling experiments

The transverse comparison of the percentage difference between the experimental results of milling force obtained and the data obtained on the simulation platform is made, and the results are shown in Fig. 11. The error between the two is between 9% and 19%, which belongs to a reasonable error range. In addition, it can be found that the experimental results of each group are slightly higher than the simulation results, because the simulation analysis is carried out under absolutely ideal conditions compared with the experiment. In the real process, the experimental results are often affected by the vibration of the

machine tool, the change of ambient temperature and other factors, which leads to the increase of the milling force.

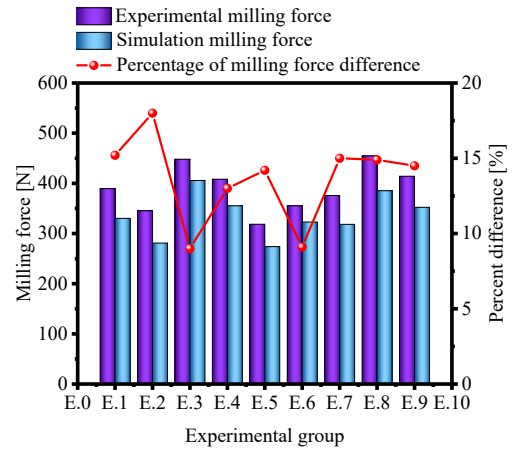

Fig. 11. Comparison of milling force experiments values and simulation values

Calculate the average and range of milling forces for four different factors at different levels, as shown in Table 5, for intuitive analysis. Through the analysis of experimental results, it is found that the influence of micro-textured period, amplitude, spacing, and width on the milling force at different levels, shown in Fig. 12. It can be clearly seen from Fig. 12 that as the micro-textured period, amplitude, and spacing increase, the milling force of the tool first decreases and then increases, and gradually decreases with the increase of micro-textured width. Further analysis shows that the reason for its change is that as the micro-textured cycle increases to a certain extent, the storage capacity of chips is improved, effectively reducing wear and further reducing milling force. As the cycle further increases, the range of micro-textured participation in the milling process decreases, thereby increasing milling force. When the amplitude of micro-texture increases within a certain range, the sharpness of the micro-textured surface increases, making it easier for the milling edge to penetrate the surface of the workpiece during the milling process, thereby effectively reducing milling force. When the amplitude of micro-texture continues to increase, it will cause significant vibration during the milling process, thereby increasing the milling force. The reason for the variation of milling force with the size of micro-textured spacing is that when the micro-textured spacing initially increases, a lubricating oil film is formed during the milling process, which can effectively reduce the friction in the milling area and thus reduce milling force. When the micro-

textured spacing further increases, it will affect the generation of lubricating oil film, increase the friction in the milling area and thus increase the milling force. As the width of the micro-texture increases, the protrusion area on the tool surface decreases, leading to a decrease in the accumulation of heat on the tool surface during the milling process, thereby reducing tool wear and extending the tool's service life. As the width of the micro-texture increases, the channel for chip removal also widens, reducing the accumulation of chips and reducing milling force.

The range method was used to analyse the range values of four factors. The primary and secondary order of the influence of micro-texture parameters on milling force is: micro-textured spacing > micro-textured period > micro-textured amplitude > micro-texture width. That is, micro-texture spacing has the greatest impact on milling force generated by milling titanium alloy, while micro-textured width has the smallest impact on milling force.

Table 5. Visual analysis table for the average milling force and factor range of four factors at different levels

	Cycle [N]	Amplitude [N]	Width [N]	Spacing [N]
Average level 1	394.3	391.2	399.8	347.1
Average level 2	360.6	372.8	389.3	358.8
Average level 3	414.8	405.8	380.8	436.9
Range	54.2	33	19	78.1

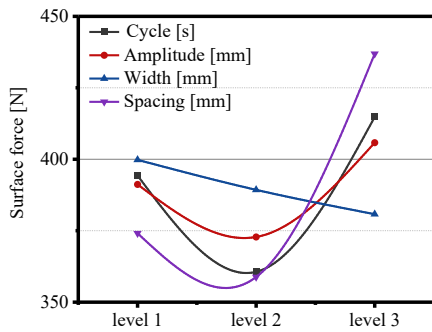

Fig. 12. The variation of milling force with different levels of sinusoidal micro-textured factors

2.3 Analysis of the Milling Temperature

An infrared thermal imager DM66 was used to record the temperature values in the milling process of each group of orthogonal experiments, and the average temperature of the milling process was calculated as the reference data of the milling temperature. The milling temperature of the measured tool without

micro-texture and the milling temperature of each group of micro-texture tools were shown in Fig. 13. As can be seen from Fig. 13 compared with the tool without micro-texture, the milling temperature generated by the micro-texture tool during the milling process decreases at a certain rate. By calculation, the maximum reduction rate of milling temperature produced by the sinusoidal micro-textured ball end milling cutter is close to 30 % compared with the non-micro-textured ball end milling cutter in nine experiments.

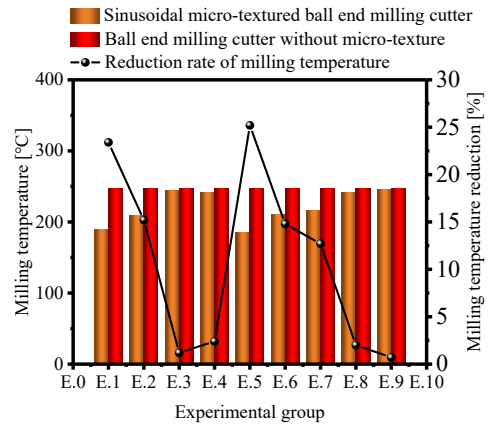

Fig. 13. Comparison of milling temperature data between nine different parameter combinations of sinusoidal micro-textured ball end milling cutter milling experiments and non-micro-textured tool milling experiments

The transverse comparison of the percentage difference between the experimental result of milling temperature obtained and the numerical value obtained in the simulation process is made, as shown in Fig. 14. The error between the two is between 2 % to 20 %, which is within the reasonable error range.

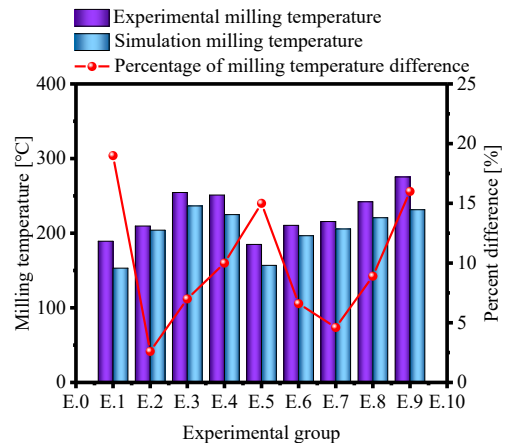

Fig. 14. Comparison of milling temperature experiments values and simulation values

After that, orthogonal analysis was carried out on the experimental data, and the orthogonal test table is shown in Table 6. The effects of micro-texture period, amplitude, spacing and width on different horizontal milling temperatures are shown in Fig. 15. It can be clearly seen from Fig. 15 that with the increase of micro-texture period, amplitude and spacing, the milling temperature of the tool first decreases and then increases, while with the increase of micro-texture width, the milling temperature first increases and then decreases.

As for the special change of milling temperature with the increase of micro-texture width, the analysis of the reason is that with the continuous increase of width, the ability to accommodate chips in the space is strong, and at the same time, the heat cannot be effectively dissipated, so the milling temperature rises more violently. When the micro-texture width increases to a certain extent, there is enough space to dissipate heat, so the milling temperature will be significantly reduced.

The range method was used to analyse the range values of the four factors. The order of influence of micro-texture parameters on milling temperature is as follows: micro-texture spacing > micro-texture amplitude > micro-texture width > micro-texture period. In other words, the micro-texture spacing has the greatest influence on the milling temperature, while the micro-texture period has the least influence on the milling temperature.

Table 6. Visual analysis table for the average milling temperature and factor range of four factors at different levels

	Cycle [°C]	Amplitude [°C]	Width [°C]	Spacing [°C]
Average level 1	217.8	218.6	213.9	216.5
Average level 2	251.5	212.2	245.3	211.9
Average level 3	244.3	246.8	218.3	249.2
Range	28.8	347.5	31.4	37.3

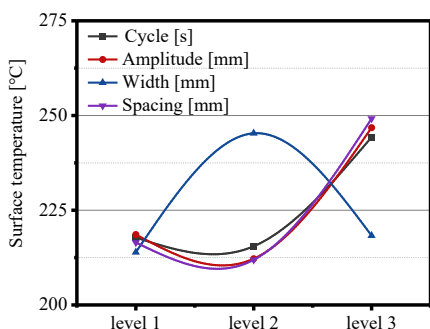

Fig. 15. The variation of milling temperature with different levels of sinusoidal micro-textured factors

2.4 Analysis of the Surface Roughness of Titanium Alloy Workpiece

The surface roughness of the milled titanium alloy workpiece was measured using an optical profile microscope model WYKO2900. In the measurement of the surface roughness of titanium alloy workpiece, the surface roughness standard Ra is used to evaluate the surface roughness of the workpiece surface, which is defined as the absolute value of the average surface height difference per unit length, and is usually used to describe the surface roughness of mechanical parts. In order to make the data more accurate, three nodes are evenly selected on each milling mark for Ra value detection, and finally the average Ra value of the three nodes is taken as the reference basis for subsequent analysis, and draw the surface roughness of each group of experimental titanium alloy workpieces as shown in Fig. 16.

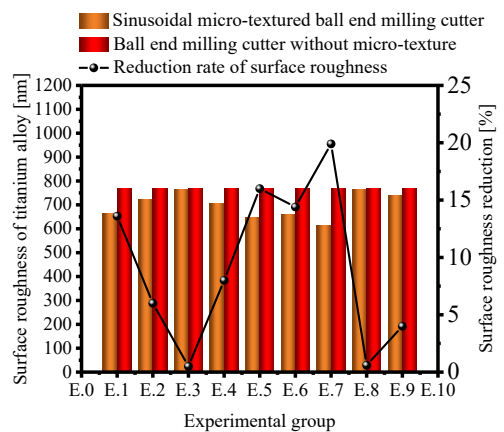

Fig. 16. Comparison chart of titanium alloy workpiece surface roughness data for nine sets of sinusoidal micro-textured ball end milling cutters in milling experiments

From Fig. 16, it can be seen that the seventh group of experiments has the lowest surface roughness of titanium alloy workpiece, which is 615.29 nm. Compared with the tool without micro-texture, the surface roughness of the titanium alloy workpiece is significantly reduced after milling by the micro-texture tool. Through calculation, the maximum reduction rate of the surface roughness of the titanium alloy workpiece can be close to 20 % in nine groups of experiments. The variation of surface roughness of the titanium alloy workpiece under level changes due to different factors is shown in Fig. 17. It can be seen that the same factor has a significant impact on the surface roughness of a titanium alloy workpiece at different levels. As the micro-textured

cycle and spacing increase, the surface roughness of the workpiece first decreases and then increases. As the micro-textured width increases, the surface roughness of the workpiece first increases and then decreases. The surface roughness of the workpiece continues to increase with the increase of the micro-texture amplitude.

Calculate the average and parameter range of surface roughness of titanium alloy workpieces for four different factors at different levels, as shown in Table 7 for intuitive analysis. Analyse the reasons for the variation of surface roughness of titanium alloy workpieces with the parameter size of the four factors, As the micro-texture cycle increases, the micro-texture itself can provide good lubrication, thus effectively reducing the surface roughness of the titanium alloy. However, as the micro-texture cycle continues to increase, the milling force and heat generated during the milling process are concentrated in smaller surface areas, resulting in an increase in surface roughness. When the micro-texture cycle is too large, it can cause interference between micro-textures, increasing instability which leads to an increase in surface roughness of the workpiece. Increasing the spacing between micro-textures to a certain extent can reduce the generation of vibrations and burrs, thereby reducing surface roughness. When the spacing is too large, the role of micro-texture weakens, thereby increasing surface roughness. When the width of the micro-texture increases to a certain extent, the storage of chips increases, resulting in chips not falling off in a timely manner and causing a certain degree of wear on the workpiece. Moreover, as the width increases, the number of sinusoidal micro-textures decreases, resulting in smaller shear forces and leaving larger burrs and protrusions on the surface of the workpiece, resulting in an increase in surface roughness. As the width of the micro-texture gradually increases, the contact area between the tool and the workpiece decreases, enhancing the storage capacity of the micro-texture. On the one hand, it reduces the wear caused by chips on the workpiece, while also reducing surface burrs and protrusions, effectively reducing low surface roughness. As the amplitude of micro-texture continues to increase, it may cause the sharpness of the micro-textured surface to be too high, causing greater vibration generated by milling, thereby affecting surface quality and increasing the roughness of titanium alloy workpiece surface.

The range method was used to analyse the range values of four factors, and the main and secondary order of the influence of micro-textured factors on the surface roughness of titanium alloys is: micro-

texture spacing > micro-texture amplitude > micro-texture period > micro-texture width. That is, micro-texture spacing has the greatest impact on the surface roughness of titanium alloys, while micro-texture width has the smallest impact on milling force.

Table 7. Visual analysis table for the average surface roughness and factor range of four factors at different levels

	Cycle [nm]	Amplitude [nm]	Width [nm]	Spacing [nm]
Average level 1	717	661.6	698.7	682.9
Average level 2	669.4	713.9	721.9	665.5
Aaverage level 3	709.3	720	675.1	747.8
Range	47.5	58.6	46.8	82.8

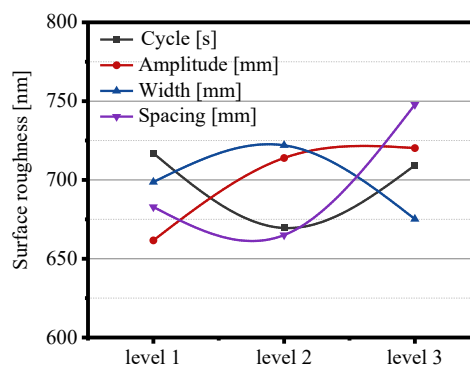

Fig. 17. The variation of titanium alloy surface roughness with different levels of sinusoidal micro-texture factors

The experimental results show that the influence of the four micro-texture parameters on milling force is as follows: micro-texture spacing > micro-texture period > micro-texture amplitude > micro-texture width, and the influence on the surface roughness of the workpiece is as follows: micro-texture spacing > micro-texture amplitude > micro-texture period > micro-texture width. Micro-textured cutting tools can effectively improve milling performance, and micro-texture spacing has the greatest impact on tool milling performance. Therefore, when milling titanium alloys with sinusoidal micro-textured ball end milling cutters, the size of micro-texture spacing should be given priority consideration to improve the milling performance of the tool.

3 PARAMETER OPTIMIZATION

By studying the orthogonal experimental group of sinusoidal micro-textured ball end milling cutters for milling titanium alloy, the magnitude of the influence of four micro-texture parameters on the milling performance of the tool was preliminarily determined.

In order to further explore the micro-texture parameters that can achieve the optimal milling performance of the tool, a multiple regression model was established with the period, width, amplitude, and spacing of the sinusoidal micro-texture as variables. The optimized parameter solution set was calculated using a genetic algorithm to select the optimal parameters in the solution set, to prepare milling tools for comparative experiments, and ultimately determine the optimal parameters for micro-texture.

3.1 Data Preprocessing

Due to the different units of milling force, milling temperature, and surface roughness, it is not possible to compare them simultaneously. Therefore, the formula for dimensionless reprocessing of three types of data is [20]:

$$B_i = c \frac{A_i}{\sqrt{\sum_{i=1}^n A_i^2}} \quad c = 1000, \quad i = 1, 2, \dots, 9. \quad (7)$$

The milling force, milling temperature, and surface roughness data were sequentially brought in to obtain non-quantitative data as shown in Table 8.

Table 8. The three milling performance parameters have no dimensional data

Experiment	Milling force	Temperature	Roughness
1	331.01	276.88	316.13
2	293.43	306.74	343.61
3	380.64	372.44	363.75
4	346.77	367.47	335.52
5	270.63	270.59	307.21
6	301.79	308.05	312.92
7	319.29	315.52	292.77
8	386.12	354.30	368.25
9	351.91	402.88	351.42

3.2 Mathematical Model Establishment

The accuracy of parameter optimization depends on the reasonable construction of the mathematical model. Therefore, before optimizing the parameters, a reasonable mathematical model should be constructed [21] to [23]. After conducting orthogonal experimental research on the milling of titanium alloy with a sinusoidal micro-textured ball end milling cutter, a multivariate linear regression equation is established with the period, width, amplitude, and spacing of the texture as independent variables regarding milling

force, milling temperature, and workpiece surface roughness. The mathematical model is as follows:

$$S = a_1L_1 + a_2L_2 + a_3L_3 + a_4L_4 + a_5L_1^2 + a_6L_2^2 + a_7L_3^2 + a_8L_4^2 + C, \quad (8)$$

where S is the optimization objective; S_1 is the micro-texture cycle; S_2 is the micro-texture width; S_3 is the micro-texture amplitude; S_4 is the micro-texture spacing; $a_1; a_2; a_3; a_4; a_5; a_6; a_7; a_8$ are the corrections for each variable to be determined; The coefficient C is a constant, and its magnitude is related to the surface properties of the tool and workpiece materials. Substitute the data in Table 5 into Eq. (7) for multiple linear regression analysis, and obtain the prediction models $S_1, S_2,$ and S_3 for milling force, milling temperature, and workpiece surface roughness values, as follows:

$$S_1 = -215.3133L_1 - 2.9657L_2 - 0.3661L_3 - 4.2279L_4 + 37.3367L_1^2 + 0.0546L_2^2 + 0.0010L_3^2 + 0.0159L_4^2 + 907.5048, \quad (9)$$

$$S_2 = -117.1L_1 - 3.4703L_2 + 4.8555L_3 - 3.1993L_4 + 22.7567L_1^2 + 0.075L_2^2 - 0.0475L_3^2 + 0.0123L_4^2 + 566.4405, \quad (10)$$

$$S_3 = -126.4717L_1 + 2.338L_2 + 1.6666L_3 - 2.5644L_4 + 20.7717L_1^2 - 0.0273L_2^2 - 0.0185L_3^2 - 0.0096L_4^2 + 600.0742. \quad (11)$$

3.3 Genetic Algorithm Optimization Parameters

Four micro-texture parameter ranges are taken as the initial values of the variables (micro-texture period: 2 to 4, micro-texture amplitude: 10 to 50, micro-texture width: 20 to 80, micro-texture spacing: 100 to 200). Set the weight ratio of milling force, milling temperature, and surface roughness to 0.3:0.2:0.5. The initial population size is set to 200, with 2000 iterations. After undergoing iterative evolution, the corresponding data is obtained by substituting it into the mathematical model. The results are multiplied by the weight ratio and summed, as shown in Fig. 18. It can be seen that the weight ratio sum values of the solutions in groups 12, 15, and 17 are the smallest.

Prepare milling tools based on the numerical values of three sets of solutions and conduct experiments. Comparing the experimental data shown in Fig. 19, it can be seen that the 15th group of data has

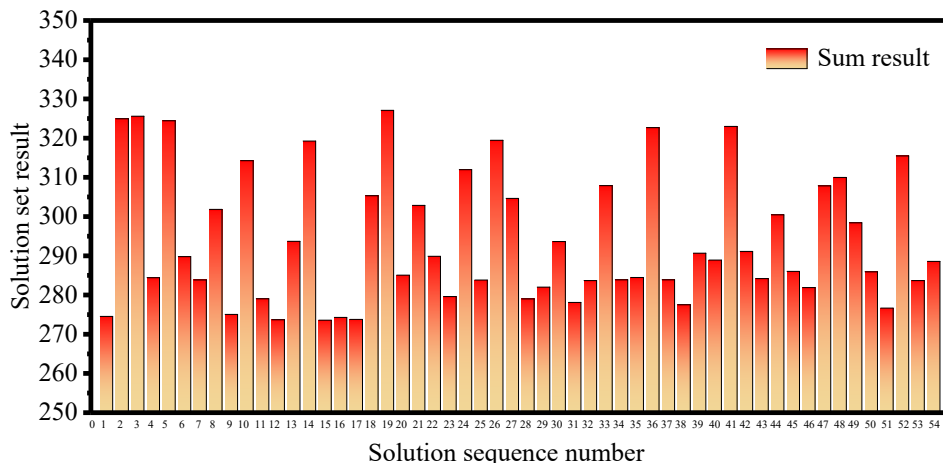

Fig. 18. Comparison chart of results of dimensionless resolution

the best result, with a milling force of 289.52 N and a surface roughness of 591.22 nm on the workpiece. The milling force of the tool and the surface roughness of the workpiece are lower than the minimum results obtained from the previous nine sets of experiments, so the fifteenth set of data is used as the optimal parameter combination for sinusoidal micro-texture.

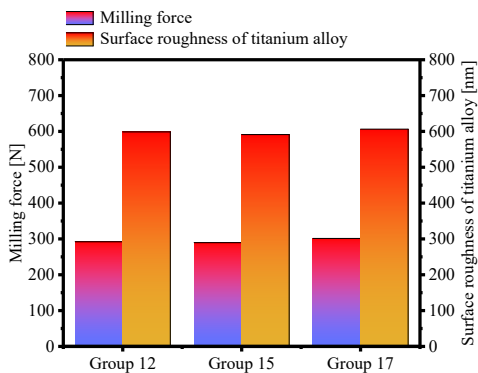

Fig. 19. Comparison chart of milling performance for three sets of optimal parameters

By constructing a mathematical model and using genetic algorithm to obtain three sets of optimal parameters, a control experiment was conducted to determine the cycle = 2.87 s and amplitude = 25.13 μm, width = 79.89 μm, spacing = 134.5 μm is the optimal combination of sinusoidal micro-textured parameters.

4 CONCLUSION

This article explores the influence of micro-texture on the milling performance of milling tools through

finite element simulation, using milling force and milling temperature as measurement standards. The milling experiment is used to determine the micro-texture parameters that have the greatest impact on the milling performance of the tool. Furthermore, genetic algorithm is used to optimize the parameter size, and the conclusion is as follows:

- 1) During the milling process, micro-texture can reduce milling force by storing chips, and can increase heat dissipation space to promote heat release, effectively reducing milling temperature. Compared with the non-textured tool, the reduction rate of the milling force of the micro-textured tool in the milling process can reach close to 30 %, the reduction rate of the milling temperature can reach close to 30 %, and the reduction rate of the roughness of the surface of the titanium alloy workpiece can reach close to 20 %. It can be seen that the micro-textured tool can effectively improve the milling performance of the tool.
- 2) Under the same milling conditions, through the range analysis of four micro-texture parameters, in the analysis of milling force, the degree of influence of micro-texture parameters on milling force is as follows: micro-textured spacing > micro-textured period > micro-textured amplitude > micro-texture width. The range of micro-texture spacing caused by the influence of different factors on milling force is 78.1 N. In the analysis of milling temperature, the degree of influence of micro-texture parameters on milling temperature is as follows: micro-texture spacing > micro-texture amplitude > micro-texture width > micro-texture period. The range

of micro-texture spacing caused by the influence of different factors on temperature is 37.3 °C. In the analysis of the surface roughness of titanium alloy, the degree of influence of micro-texture parameters on the surface roughness of titanium alloy is in the following order: micro-texture spacing > micro-texture amplitude > micro-texture period > micro-texture width. The range of micro-texture spacing caused by the influence of different factors on surface roughness is 82.8 µm. Therefore, the improvement effect of micro-texture spacing on cutter milling performance is the best among the four parameters.

- 3) After optimizing the parameters using genetic algorithm and conducting comparative experiments, it was found that when the micro-texture cycle is 2.87, the amplitude is 25.13 µm, the width is 79.89 µm, and the spacing is 134.54 µm, the milling performance of the sinusoidal micro-textured milling cutter is optimal.

5 ACKNOWLEDGEMENTS

The authors would like to thank the members of the project team for their dedication and efforts, and the teachers and schools for their help. The authors declare no conflicts of interest. Here we need to thank the following organizations for their strong support “Natural Science Foundation of Jilin Province - General Project, Study on the Machinability of Milling Titanium Alloy with Micro-textured Milling Cutter: 20220101227JC” and “Research on Key Technologies and Equipment Development for Riveting and Inspection of Automotive Brake piston Components: 20220201043GX”.

6 REFERENCES

- [1] Chen, Z., Liu, Y., Jin, F., Ma, X., Chai, L., Cui, Y. (2019). Research status and progress of high-temperature resistant titanium alloys for aircraft engines at 650 °C. *Aviation Manufacturing Technology*, vol. 62, p. 22-30, DOI:10.16080/j.issn1671-833x.2019.19.022. (in Chinese)
- [2] Sarma, J., Kumar, R., Sahoo, A.K., Panda, A. (2020) Enhancement of material properties of titanium alloys through heat treatment process: A brief review. *Materials Today: Proceedings*, vol. 23, p. 561-564, DOI:10.1016/j.matpr.2019.05.409.
- [3] Tong, X., Yang, S., He, C., Zheng, M. (2019). Multi objective optimization of cutting performance of variable density micro textured ball end milling cutters. *Journal of Mechanical Engineering*, vol. 55, no. 21, p. 221-232.
- [4] Bodunrin, M.O., Chown, L.H., Omotoyinbo, J.A. (2021). Development of low-cost titanium alloys: A chronicle of challenges and opportunities. *Materials Today: Proceedings*, vol. 38, p. 564-569, DOI:10.1016/j.matpr.2020.02.978.
- [5] Shah, S.R., Liu, G., Özel, T. (2019). Finite element simulations of chip serration in titanium alloy cutting by considering material failure. *Procedia CIRP*, vol. 82, p. 320-325, DOI:10.1016/j.procir.2019.04.153.
- [6] Cao, T., Li, Z., Zhang, S., Zhang, W. (2023). Cutting performance and lubrication mechanism of microtexture tool with continuous lubrication on tool-chip interface. *The International Journal of Advanced Manufacturing Technology*, vol. 125, p.1815-1826, DOI:10.1007/S00170-023-10821-7.
- [7] Ali, S., Abdallah, S., Pervaiz, S. (2022). Predicting Cutting force and primary shear behavior in micro-textured tools assisted machining of AISI 630: Numerical Modeling and Taguchi Analysis. *Micromachines*, vol. 13, no. 1, 91, DOI:10.3390/M13010091.
- [8] Kaushalandra, P., Liu, G., R.,S.S., Tuğrul, Ö. (2020). Effect of Micro-Textured Tool Parameters on Forces, Stresses, Wear Rate, and Variable Friction in Titanium Alloy Machining. *Journal of Manufacturing Science and Engineering*, vol. 142, DOI:10.1115/1.4045554.
- [9] Pan, C., Li, Q., Hu, K., Jiao, Y., Song, Y. (2018). Study on surface roughness of Gcr15 machined by micro-texture PCBN tools. *Machines*, vol. 6, no. 3, 42, DOI:10.3390/machines6030042.
- [10] Zhang, Y., Sun, T., Song, W. (2022). Parameter optimization of ball-end milling cutter with blunt-round edge and micro-texture on flank. *Ferroelectrics*, vol. 593, no. 1, p. 132-144, DOI:10.1080/00150193.2022.2076441.
- [11] Kumar, S.A., Sunil, J. (2022). Hybrid laser and micro milling methods for higher depth microchannel fabrication. *Journal of Manufacturing Processes*, vol. 81, p. 672-679, DOI:10.1016/J.JMAPRO.2022.07.018.
- [12] Yang, S., Zhou, Y., Zhang, Y., Tong, X., Liu, W. (2017). Prediction of surface roughness of titanium alloy milling with micro textured ball end milling cutter. *Journal of Harbin Institute of Technology*, vol. 22, no. 3, p. 141-146, DOI:10.15938/j.jhust.2017.03.026. (in Chinese)
- [13] Wang, P., Wang, D. (2020). Evaluation of different tool geometries in the finite element simulation of ultrasonic-assisted drilling of Ti6Al4V. *Journal of the Brazilian Society of Mechanical Sciences and Engineering*, vol. 42, 181, DOI:10.1007/s40430-020-2266-x.
- [14] Dai, C., Yin, Z., Zhao, M., Cao, Z., Li, H. (2021). The influence of inclination angle and speed ratio of ultrasonic elliptical vibration cutting trajectory on the microstructure of workpiece surface. *Tool Technology*, vol. 55, p. 34-38. (in Chinese)
- [15] Tong, X., Shen, J., Su, S. (2021). Properties of variable distribution density of micro-textures on a cemented carbide surface. *Journal of Materials Research and Technology*, vol. 15, p. 1547-1561, DOI:10.1016/j.jmrt.2021.08.051.
- [16] Li, Q., Zeng, Y., Zhao, M., Tian, R. (2020). Simulation analysis of the influence of micro-texture parameters on tool strength based on ANSYS. *Journal of Physics: Conference Series*, vol. 1654, 012076, DOI:10.1088/1742-6596/1654/1/012076.
- [17] Ni, S., Zhang, Y., Li, J., Wu, Y. (2022). Effect of microbevel parameters on lubrication performance of heavy-duty hydrostatic thrust bearing. *Industrial Lubrication and Tribology*, vol. 74, no. 9, p. 1092-1100, DOI:10.1108/ILT-04-2022-0116.

- [18] Karandikar, J., Chaudhuri, A., No, T., Smith, S., Schmitz, T. (2022). Bayesian optimization for inverse calibration of expensive computer models: A case study for Johnson-Cook model in machining. *Manufacturing Letters*, vol. 32, p. 32-38, DOI:10.1016/J.MFGLET.2022.02.001.
- [19] Liang, P., Zhang, J., Kong, N. (2023). A modified Johnson-Cook constitutive model for titanium alloy TA31 and its implementation into FE. *Materials Testing*, vol. 65, p. 192-201, DOI:10.1515/MT-2022-0371.
- [20] Zheng, Z., Ni, C., Yang, Y., Bai, Y., Jin, X. (2021). Numerical Analysis of serrated chip formation mechanism with Johnson-Cook parameters in micro-cutting of Ti6Al4V. *Metals*, vol. 11, no. 1, 102, DOI:10.3390/MET11010102.
- [21] Gao, X, Li, X. (2022). Comparison of dimensionless methods in multiple linear regression models. *Statistics and Decision Making*, vol. 38, p. 5-9, DOI:10.13546/j.cnki.tjyc.2022.06.001. (in Chinese)
- [22] Cruz, D.C., Sordi, V.L., Ventura, C.E. (2020). Surface analysis of WC-5%Co cemented tungsten carbide cutting insert after plunge-face grinding. *The International Journal of Advanced Manufacturing Technology*, vol. 108, p. 323-330, DOI:10.1007/s00170-020-05382-y.
- [23] Kilickap, E., Yardimeden, A., Çelik, Y.H. (2017). Mathematical modelling and optimization of cutting force, tool wear and surface roughness by using artificial neural network and response surface methodology in milling of Ti-6242S. *Applied Sciences*, vol. 7, no. 10, 1064, DOI:10.3390/app7101064.